

MERA CLUB CHAIR

ASSEMBLY INSTRUCTIONS

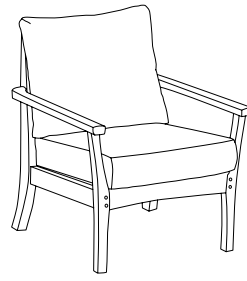

COMPONENTS

① Right Arm with Leg
Quantity: 1

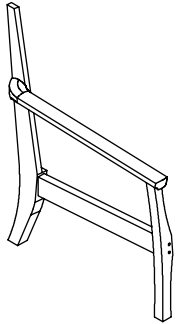

② Left Arm with Leg
Quantity: 1

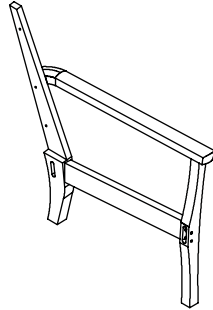

③ Backrest
Quantity: 1

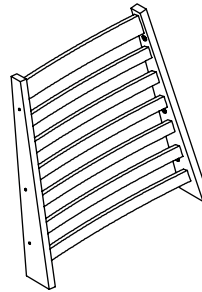

④ Seat
Quantity: 1

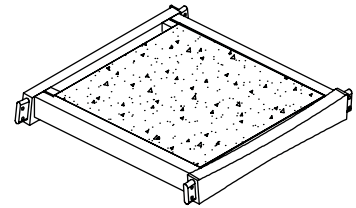

HARDWARE

A Machine Bolt
Quantity: 6

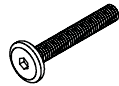

B Wooden Dowel
Quantity: 9



C Allen Wrench
Quantity: 1

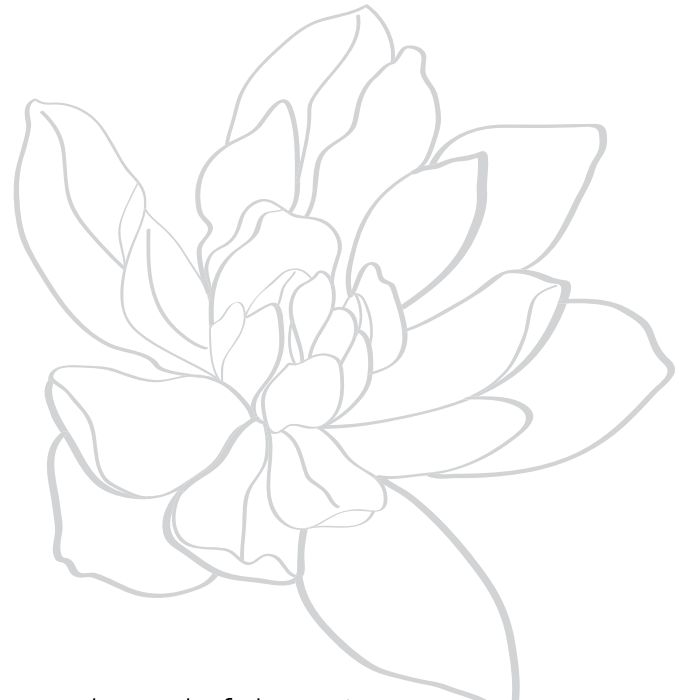
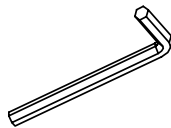

Thoughtful Design **MADE RIGHT**

INSTRUCTIONS

STEP 1

Insert tenons of seat assembly ④ into mortises of arm & leg frames ①②. Left and right angled tenons connect to the BACK LEGS.

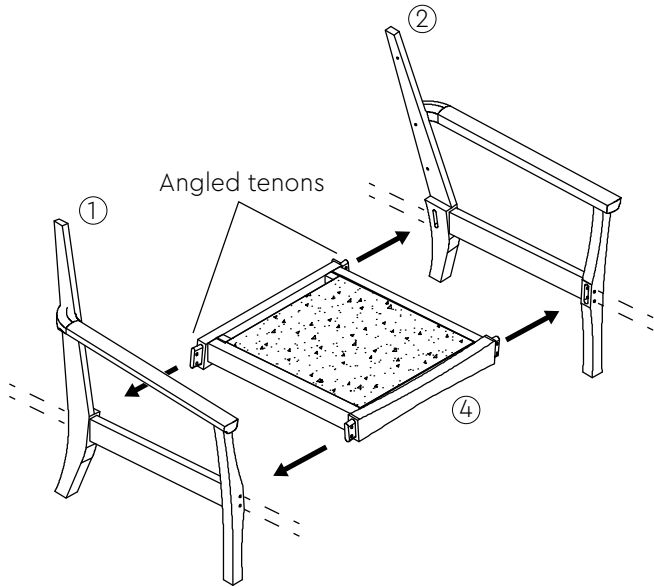

STEP 2

Insert backrest ③ into assembly, aligning with the top of arm & leg frame top. Attach with 6 machine bolts and tighten firmly.

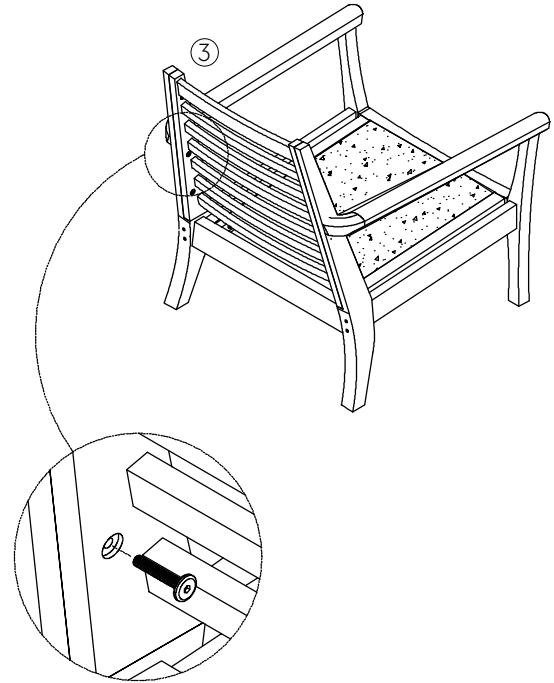

STEP 3

Insert dowel plugs into all 4 legs. Push in firmly until flush with surface.

